

Ex

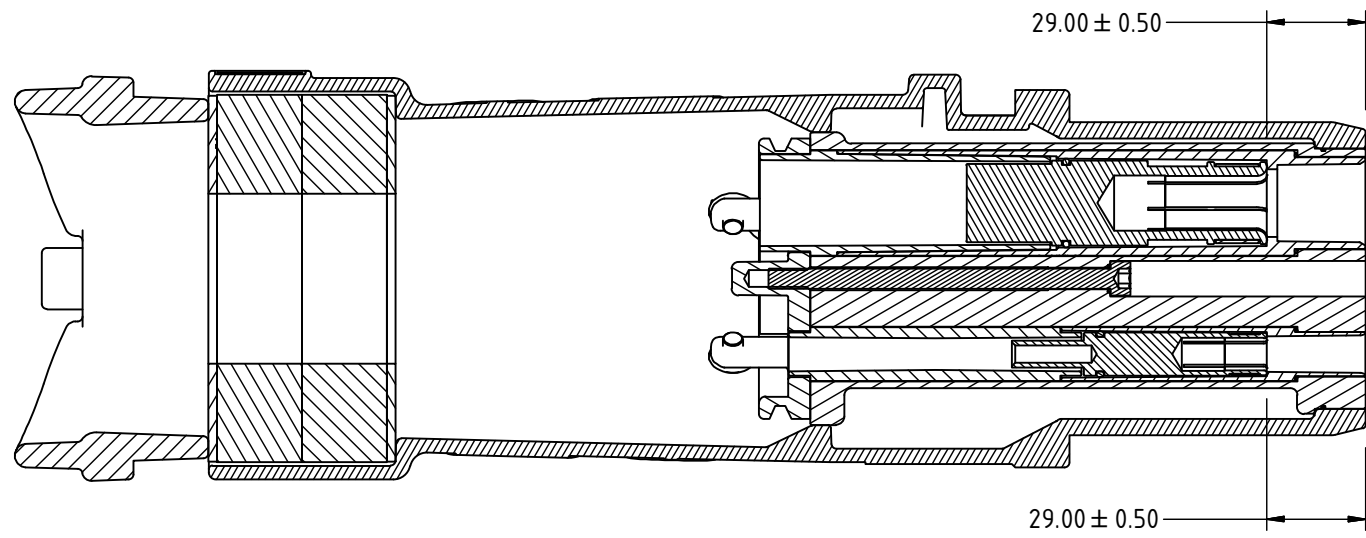

SECTION VIEW
PLUG - 660V 300A 4 PIN

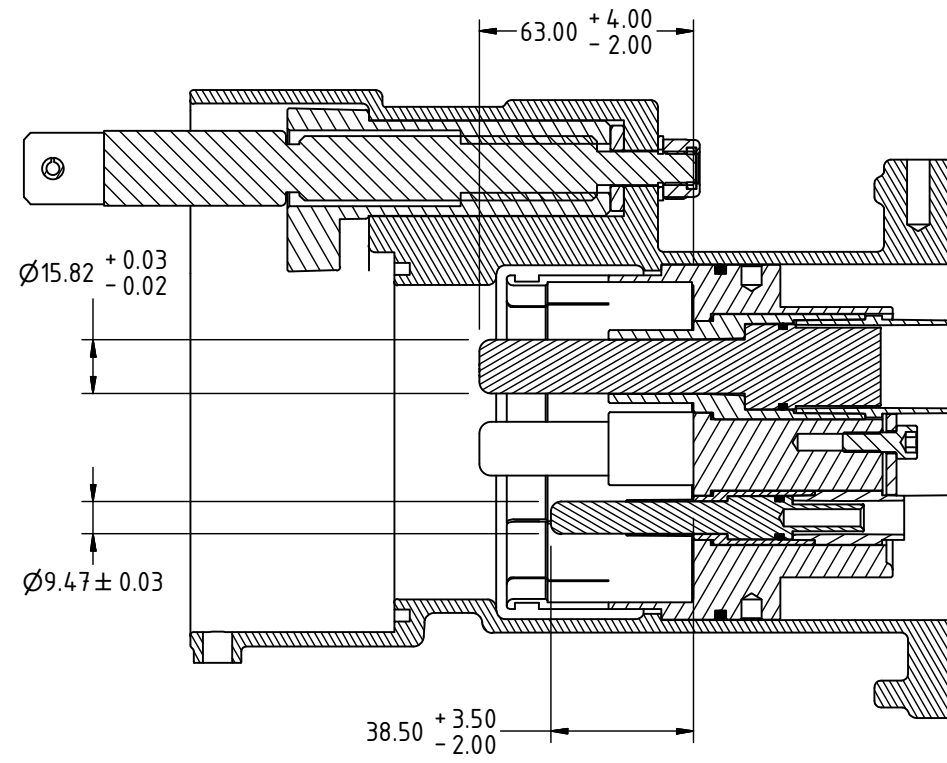

SECTION VIEW
RECEPTACLE - 660V 300A 4 PIN

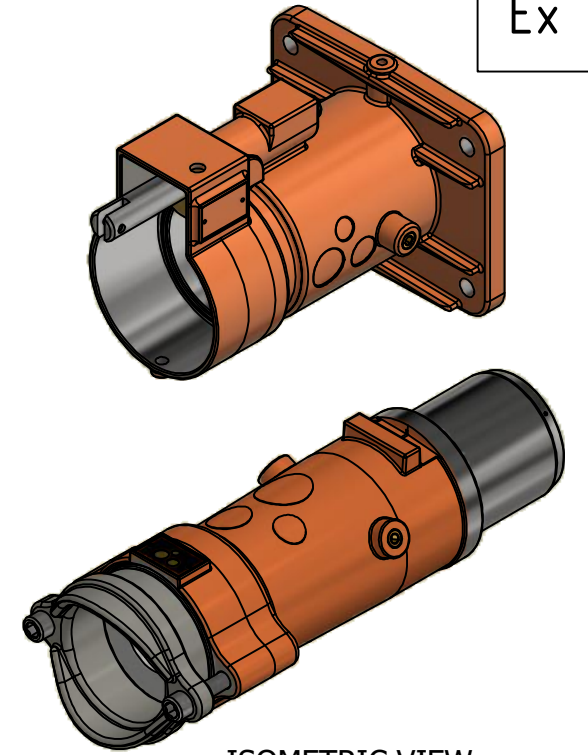

ISOMETRIC VIEW
PLUG & RECEPTACLE
660V 300A 4 PIN

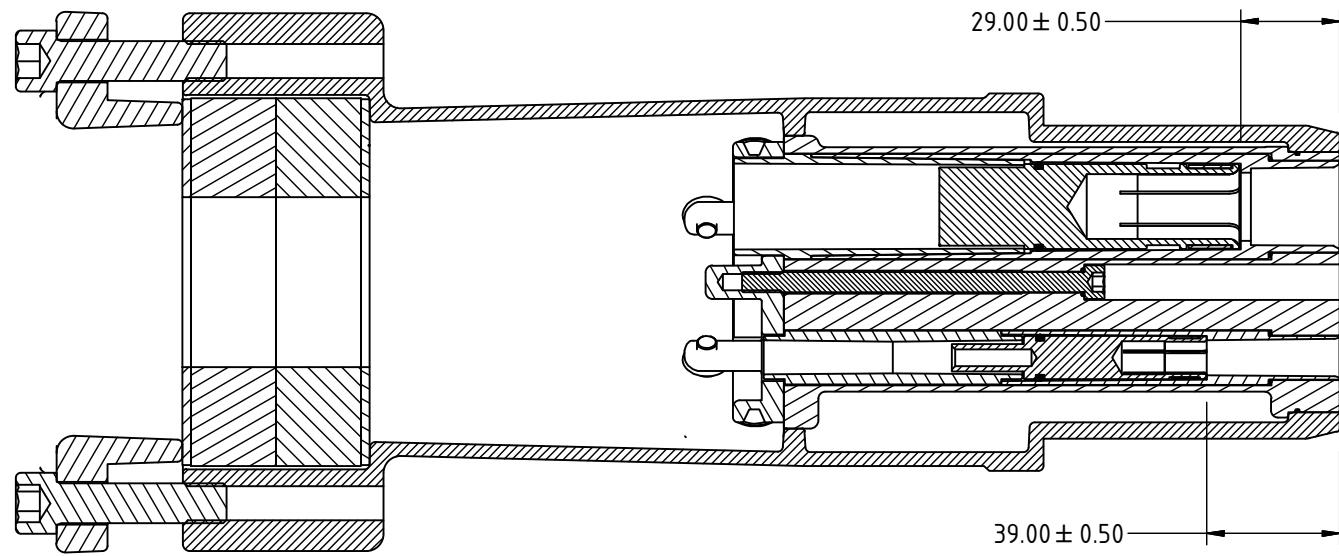

SECTION VIEW
PLUG - 660V 425A 4 PIN

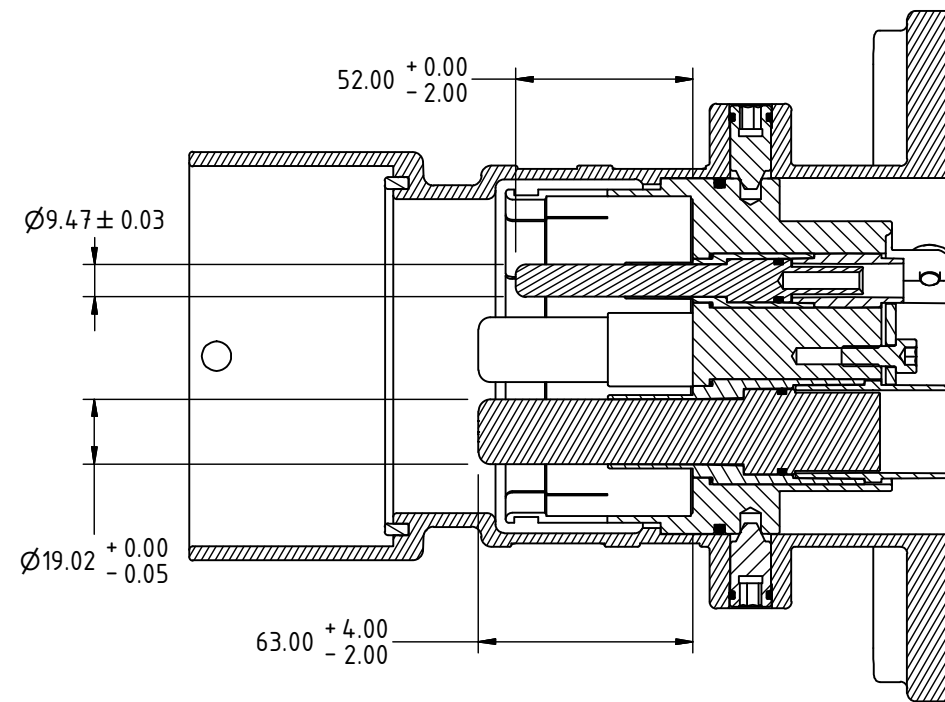

SECTION VIEW
RECEPTACLE - 660V 425A 4 PIN

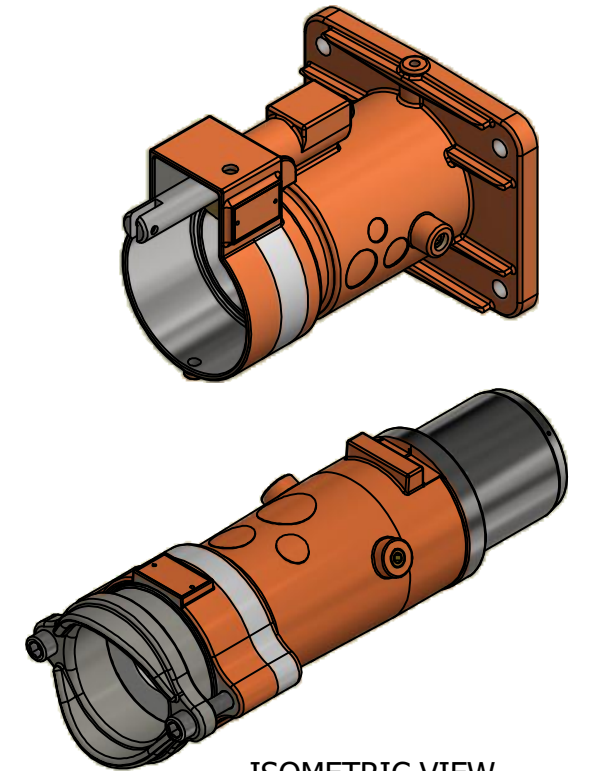

ISOMETRIC VIEW
PLUG & RECEPTACLE
660V 425A 4 PIN

AUSPROOF PTY LTD

© COPYRIGHT RESERVED

DRAWN BY

A.Castle

APPROVED BY

C.Taylor

SIZE

A3

DRAWING NUMBER
ExRPR300M2-PIN
LENGTHS

PRODUCT NAME
300 PHASE & PILOT
LENGTHS 660V 4P

0

REVISION NUMBER

10/07/2023

REVISION DATE

A.Castle

REVISION BY

CONTACT DETAILS

REVISION DESCRIPTION

DIMENSIONS (Metric-millimetre-mm)
UNLESS OTHERWISE SPECIFIED

X.X 0.1
X.XX 0.05

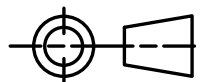

ALL SURFACES TO
UNLESS OTHERWISE NOTED