

SECTION VIEW
PLUG - 3300V 300A 6 PIN

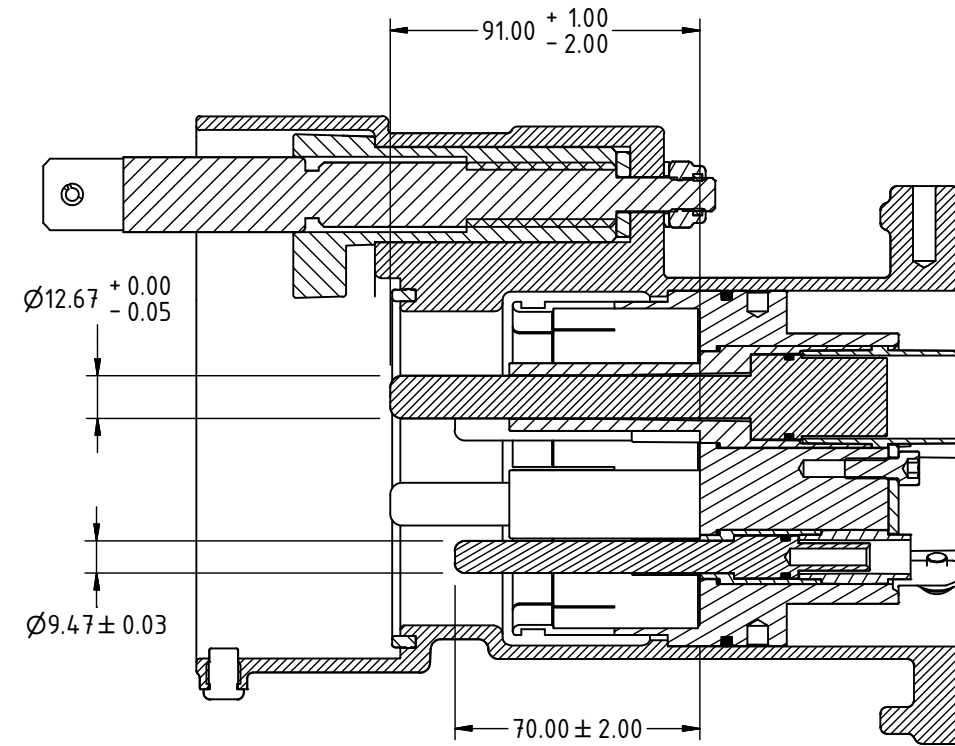

SECTION VIEW
RECEPTACLE - 3300V 300A 6 PIN

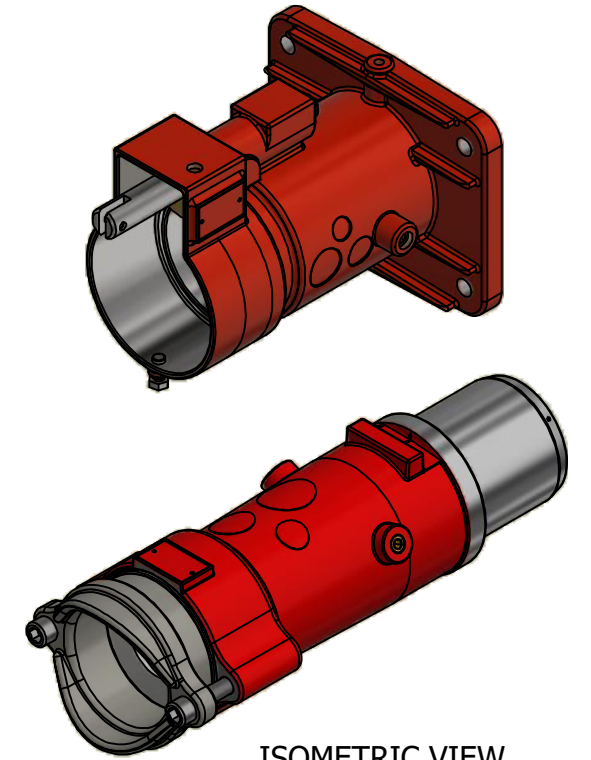

ISOMETRIC VIEW
PLUG & RECEPTACLE
3300V 300A 6 PIN

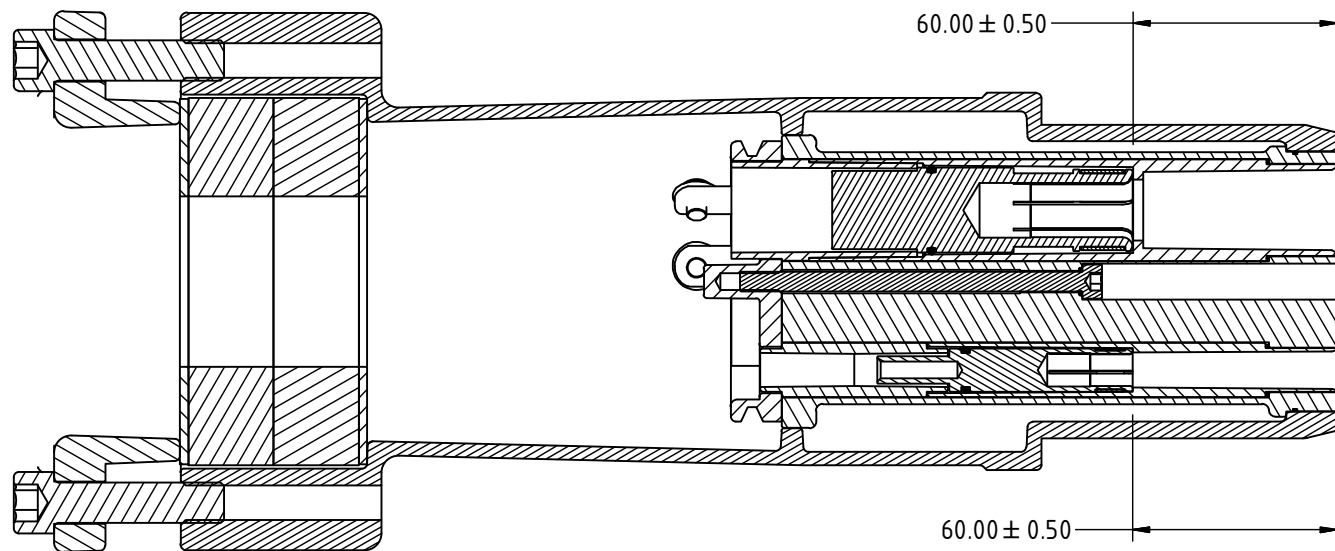

SECTION VIEW
PLUG - 3300V 425A 6 PIN

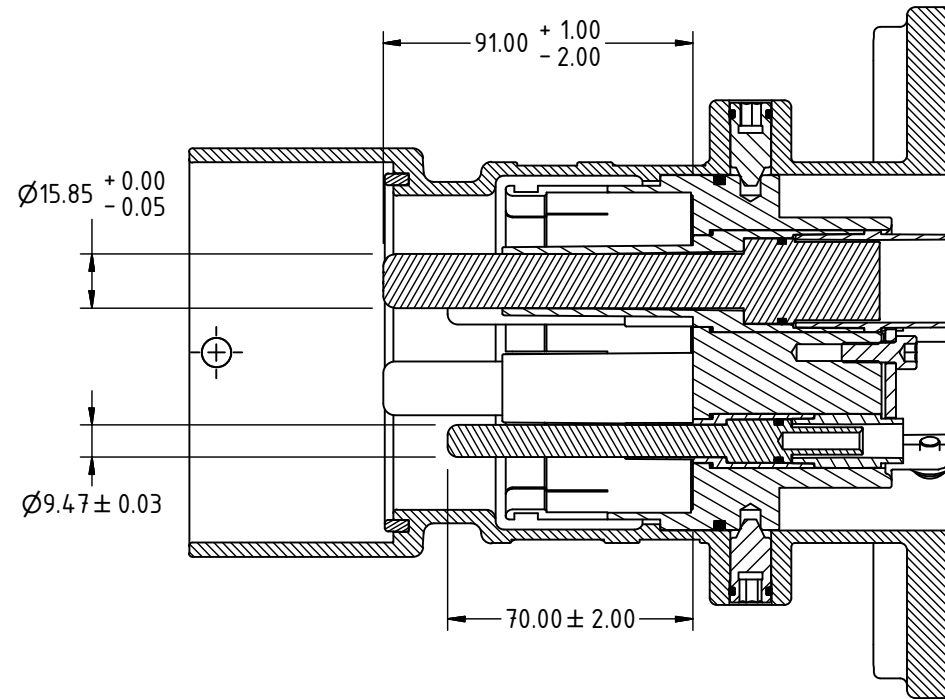

SECTION VIEW
RECEPTACLE - 3300V 425A 6 PIN

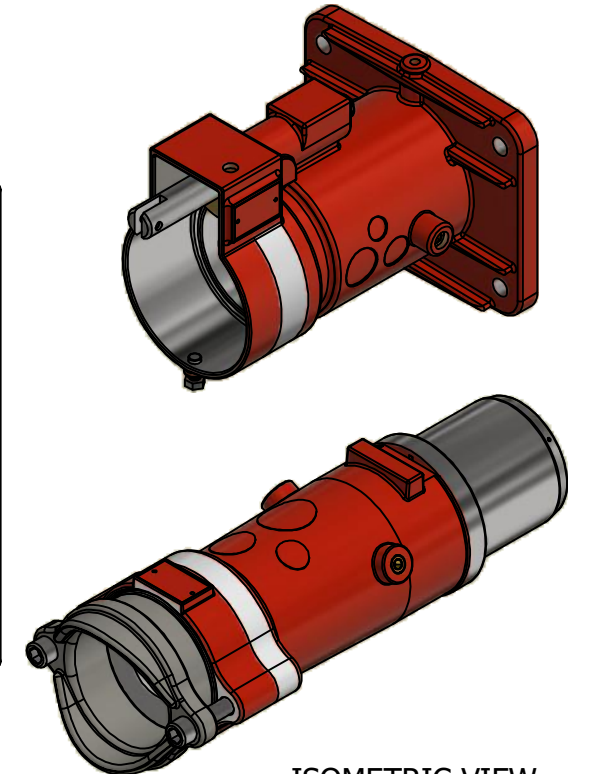

ISOMETRIC VIEW
PLUG & RECEPTACLE
3300V 425A 6 PIN

AUSPROOF PTY LTD		DRAWN BY A.Castle		DRAWING NUMBER PL/AL - PIN LENGTHS		PRODUCT NAME 300 PHASE & PILOT LENGTHS 3300V 6P		0		10/07/2023		A.Castle		CONTACT DETAILS	
© COPYRIGHT RESERVED		APPROVED BY C.Taylor		SIZE A3		REVISION NUMBER		REVISION DATE		REVISION BY		REVISION DESCRIPTION			
DIMENSIONS (Metric-millimetre-mm) UNLESS OTHERWISE SPECIFIED		X.X 0.1 X.XX 0.05		ALL SURFACES TO UNLESS OTHERWISE NOTED											